

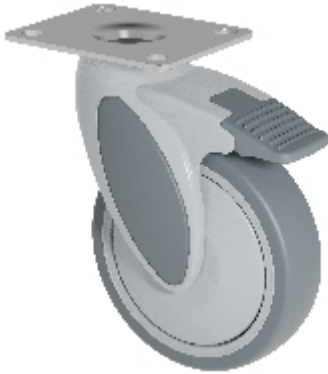









Swivel castor with total brake mounted behind:

KSF2-51C-P100 (VIVAX 2.0)



Technical data

Diameter		125 mm
Wheel width		32 mm
Height		168,5 mm
Offset		46 mm
Top plate dimensions		100x80 mm
Top plate hole diameter		9 mm
Dist. between holes		80x60/76x55 mm
Load capacity		100 kg
Weight		720 g

Technical description

plastic castor

fork made of high-strength impact-resistant nylon

swivel fork head with sealed deep groove ball bearing



Wheel

TPE tread (Shore A 87)

polypropylene wheel body

thread guard

ball bearing

non-oiling

on request further variants available